

48"

Item Number:
147-114-5236
147-114-5266
147-114-5276
147-114-5286
147-V48-BW

JAMES MARTIN

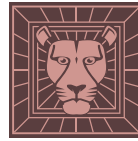

VANITIES™

Brookfield 48" Single Vanity
Cabinet w/Drawers
Diagrams with Dimensions
page 01 of 03

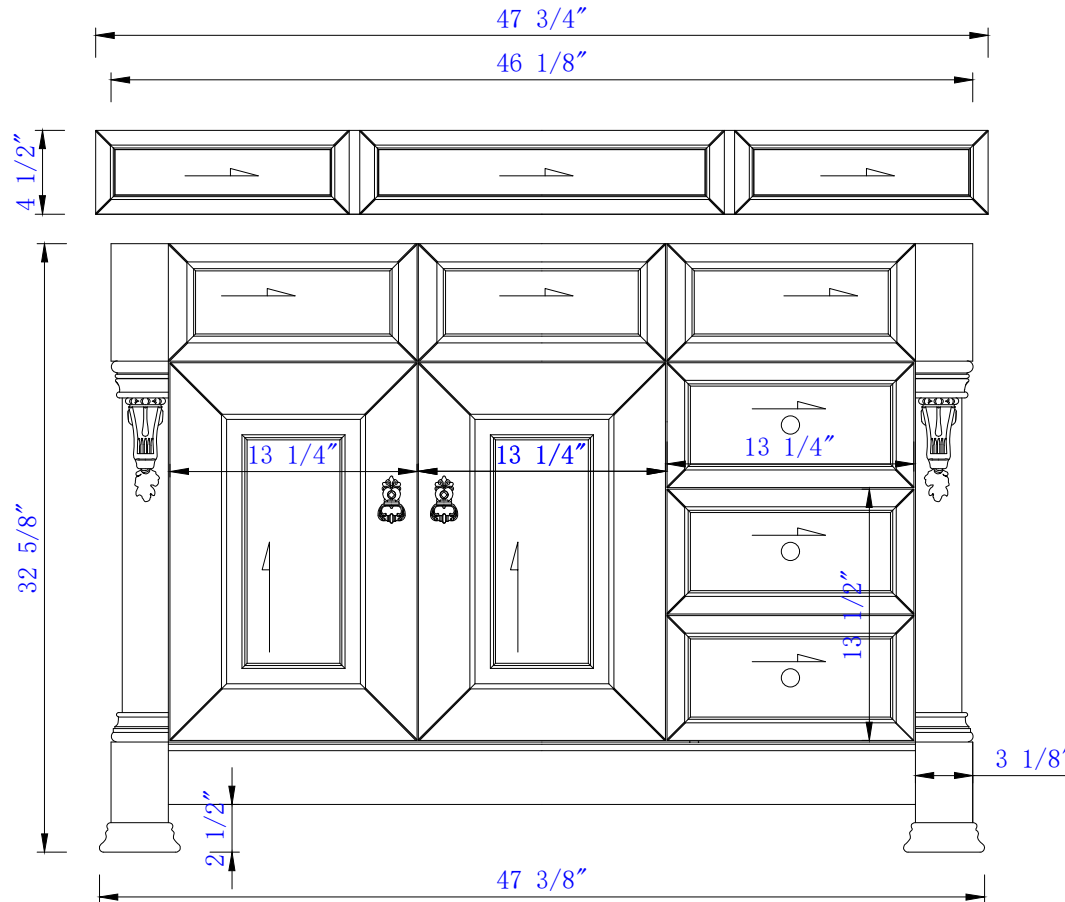

NOTE ONE: Countertops are not shown in these diagrams .(Cabinet Only)

NOTE TWO: Wood Backsplash (Shown) is designed for the molding detail to align with sinks in James Martin's Optional Countertops.

Customers' own countertops and sinks may align differently.

Please consult our website for Countertop Diagrams: www.jamesmartinvanities.com

Version:202107

48"

Item Number:
147-114-5236
147-114-5266
147-114-5276
147-114-5286
147-V48-BW

JAMES MARTIN

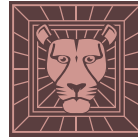

VANITIES™

Brookfield 48" Single Vanity
Cabinet w/Drawers
Diagrams with Dimensions
page 02 of 03

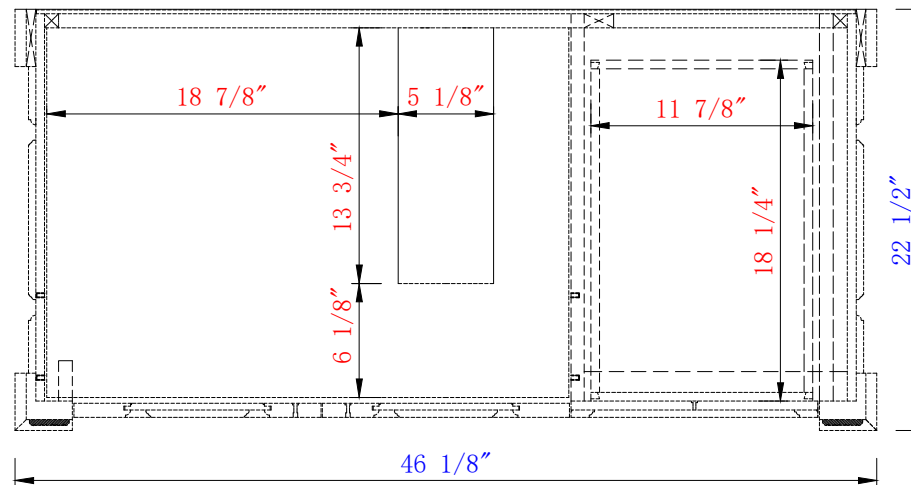
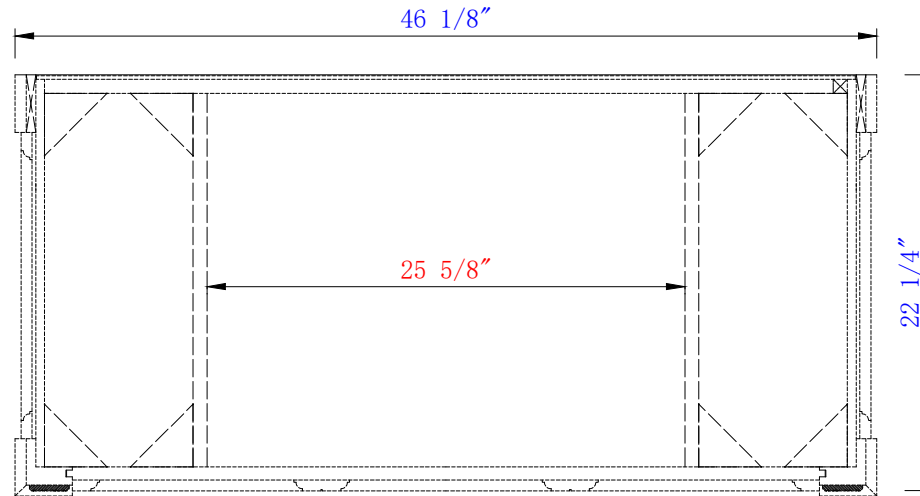

NOTE ONE: Countertops are not shown in these diagrams .(Cabinet Only)

NOTE TWO: Internal Shelves (Shown) are designed to align with sinks in James Martin's Optional Countertops.

Customers' own countertops and sinks may align differently.

Please consult our website for Countertop Diagrams: www.jamesmartinvanities.com

Version:202107

48"

Item Number:
147-114-5236
147-114-5266
147-114-5276
147-114-5286
147-V48-BW

JAMES MARTIN

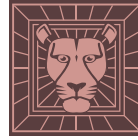

VANITIES™

Brookfield 48" Single Vanity
Cabinet w/Drawers
Diagrams with Dimensions
page 03 of 03

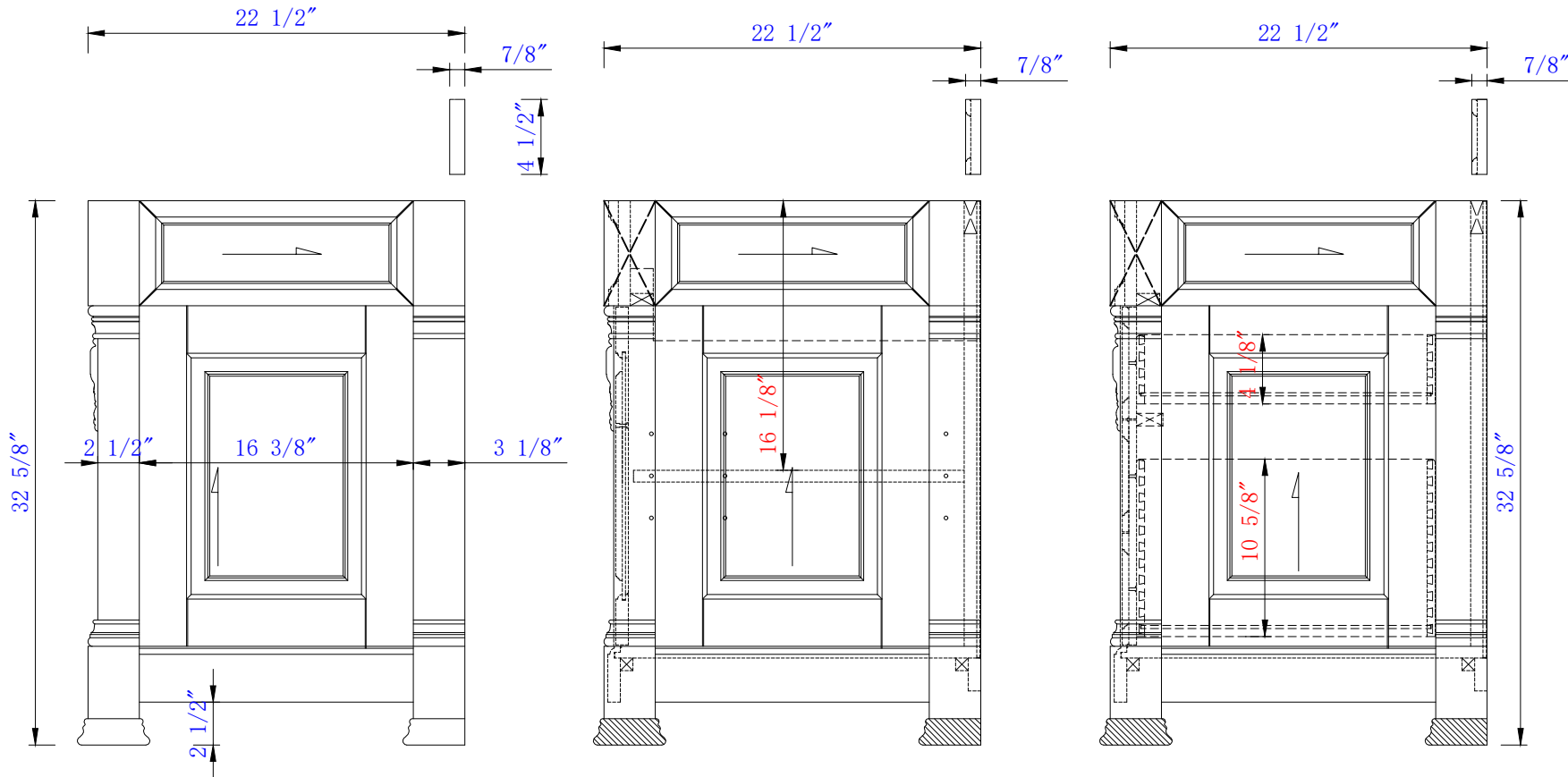

NOTE ONE: Countertops are not shown in these diagrams .(Cabinet Only)

NOTE TWO: Wood Backsplash (Shown) is designed for the molding detail to align with sinks in James Martin's Optional Countertops.

Customers' own countertops and sinks may align differently.

Please consult our website for Countertop Diagrams: www.jamesmartinvanities.com

Version:202107

1219mm

Item Number:
147-114-5236
147-114-5266
147-114-5276
147-114-5286
147-V48-BW

JAMES MARTIN

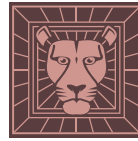

VANITIES™

Brookfield 1219mm Single Vanity
Cabinet w/Drawers
Diagrams with Dimensions
page 01 of 03

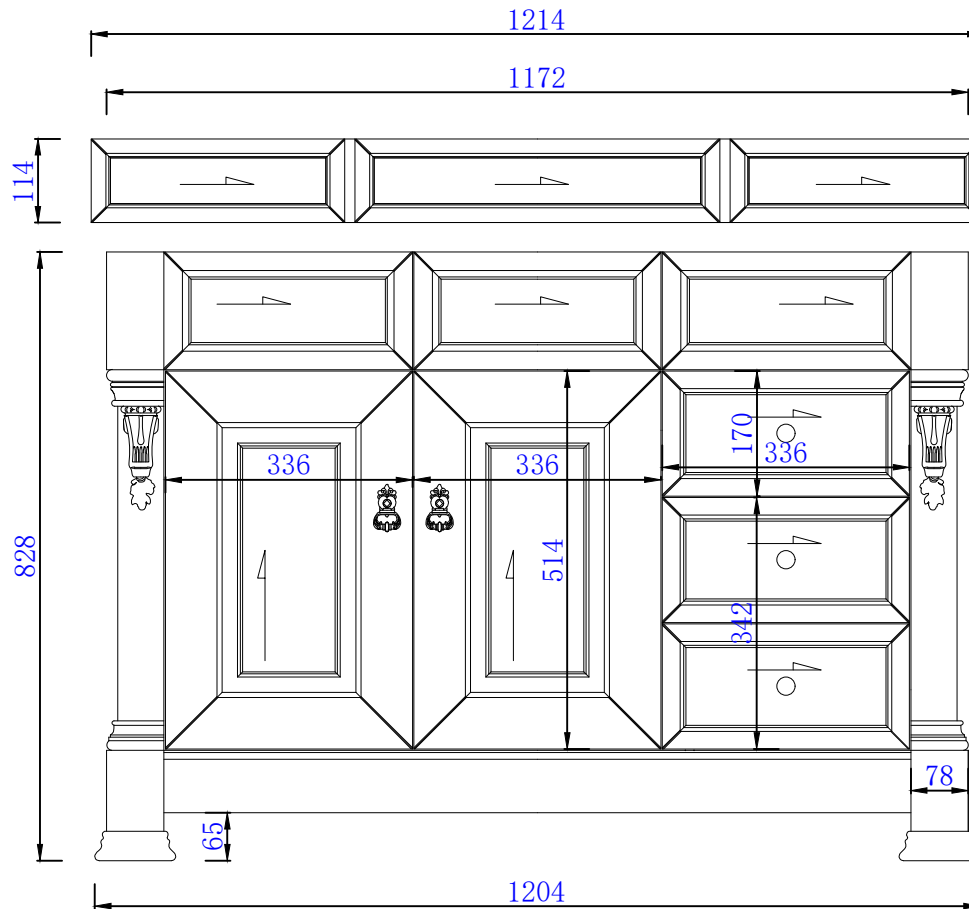

NOTE ONE: Countertops are not shown in these diagrams .(Cabinet Only)

NOTE TWO: Wood Backsplash (Shown) is designed for the molding detail to align with sinks in James Martin's Optional Countertops.

Customers' own countertops and sinks may align differently.

Please consult our website for Countertop Diagrams: www.jamesmartinvanities.com

Version:202107

1219mm

Item Number:
147-114-5236
147-114-5266
147-114-5276
147-114-5286
147-V48-BW

JAMES MARTIN

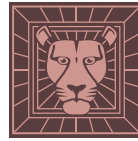

VANITIES™

Brookfield 1219mm Single Vanity
Cabinet w/Drawers
Diagrams with Dimensions
page 02 of 03

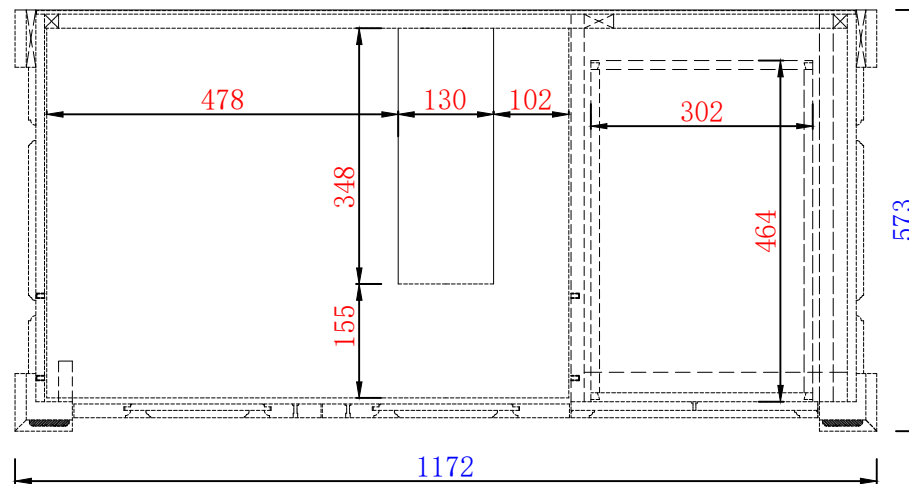
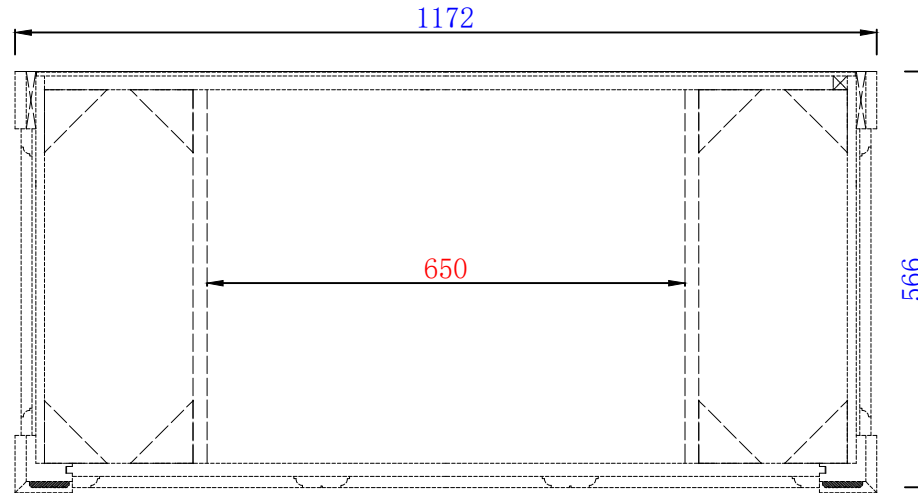

NOTE ONE: Countertops are not shown in these diagrams .(Cabinet Only)

NOTE TWO: Internal Shelves (Shown) are designed to align with sinks in James Martin's Optional Countertops.

Customers' own countertops and sinks may align differently, and modification may be required.

Please consult our website for Countertop Diagrams: www.jamesmartinvanities.com

Version:202107

1219mm

Item Number:
147-114-5236
147-114-5266
147-114-5276
147-114-5286
147-V48-BW

JAMES MARTIN

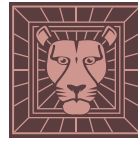

VANITIES™

Brookfield 1219mm Single Vanity
Cabinet w/Drawers
Diagrams with Dimensions
page 03 of 03

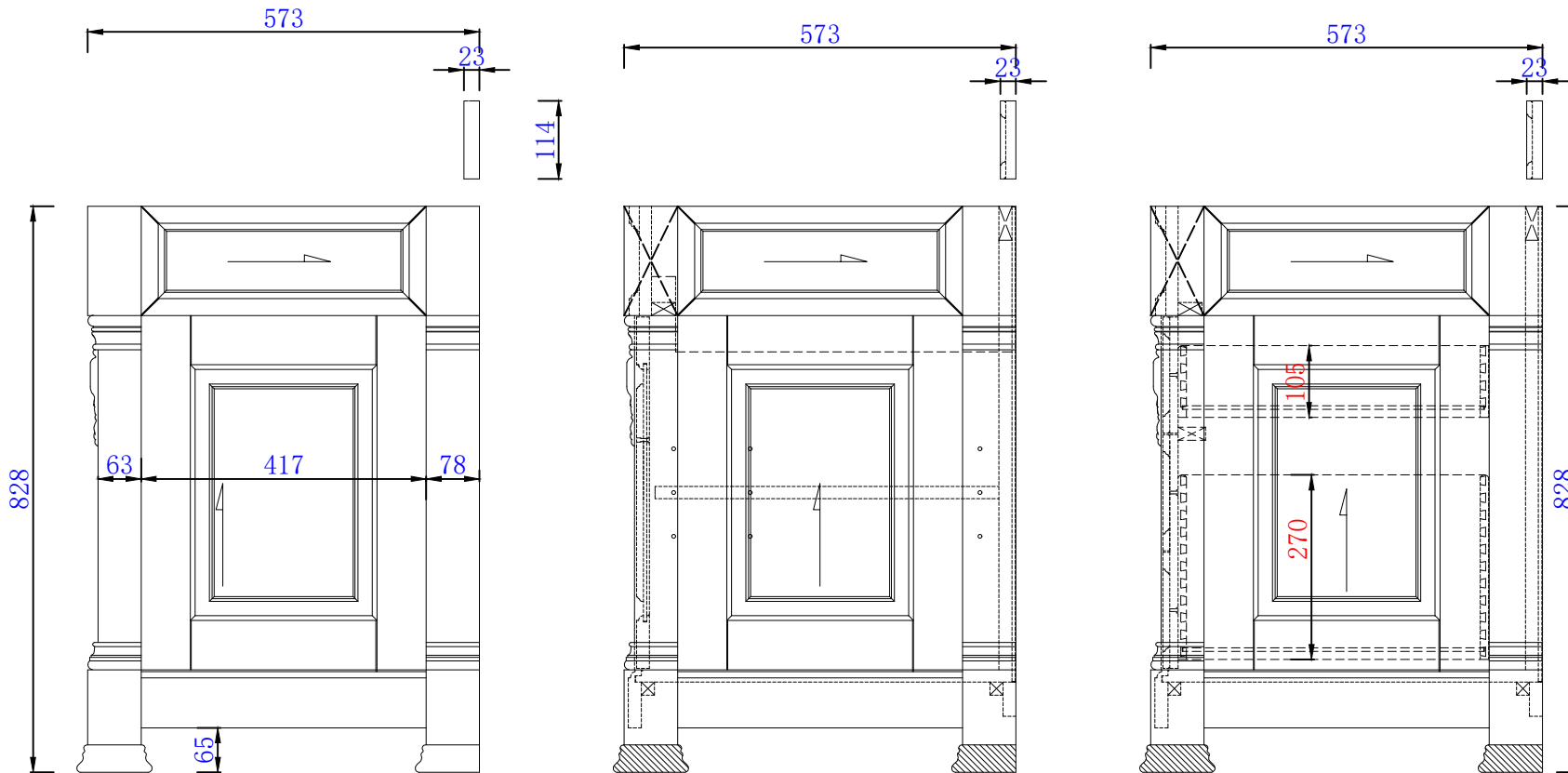

NOTE ONE: Countertops are not shown in these diagrams .(Cabinet Only)

NOTE TWO: Wood Backsplash (Shown) is designed for the molding detail to align with sinks in James Martin's Optional Countertops.

Customers' own countertops and sinks may align differently.

Please consult our website for Countertop Diagrams: www.jamesmartinvanities.com

Version:202107